

# KLEUR BOEK



Hardeman | van Harten

Dak & wandbeplating



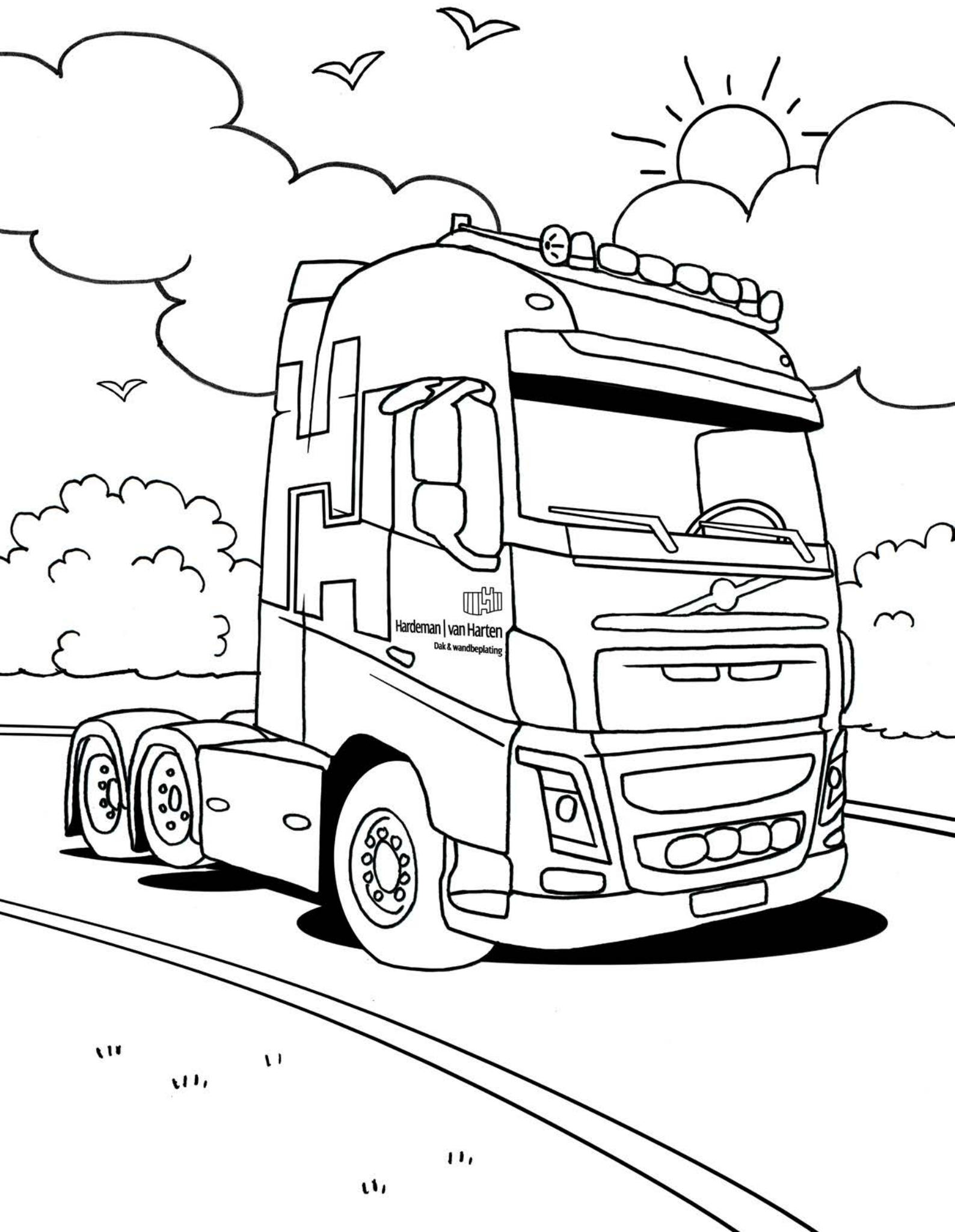

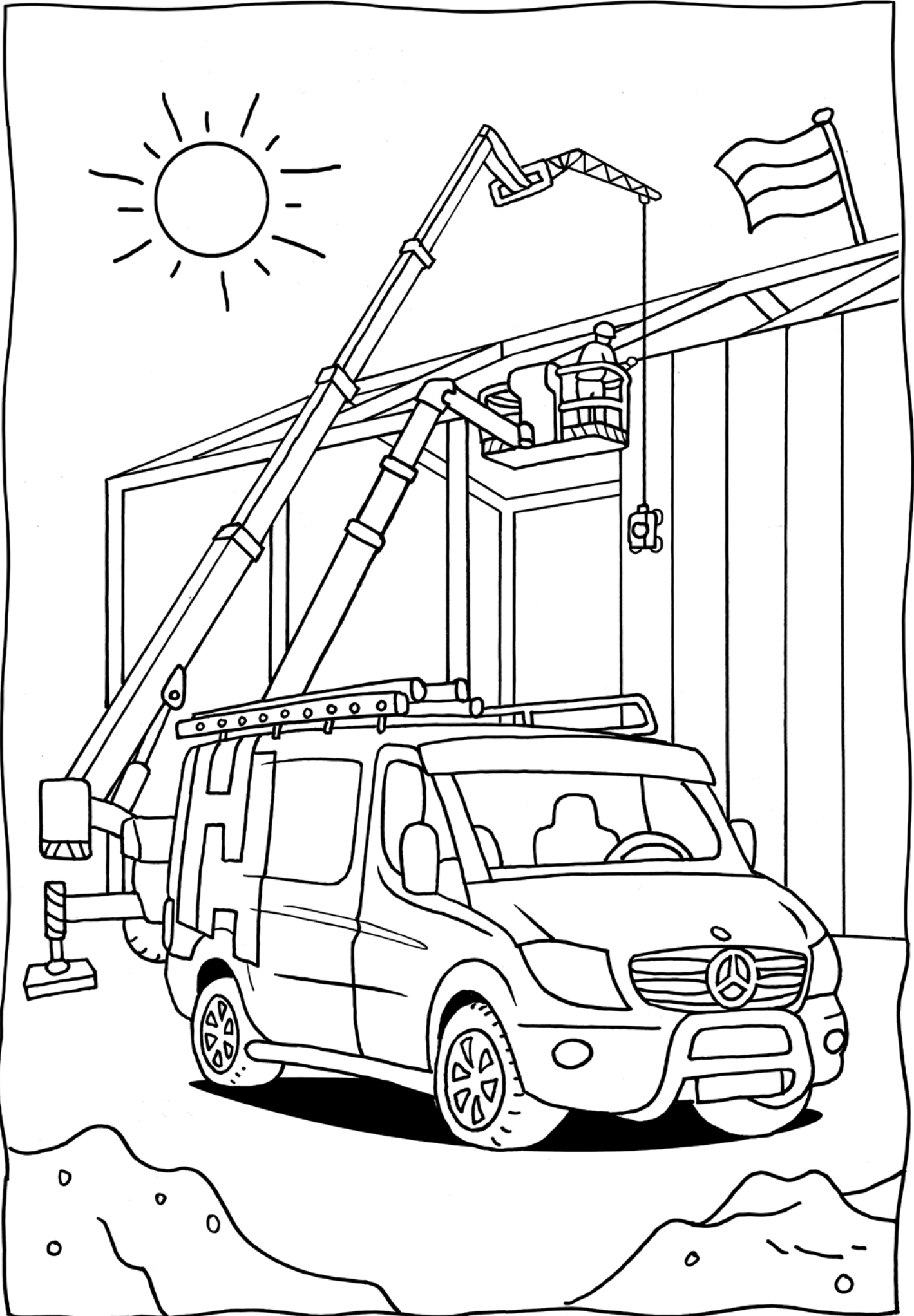

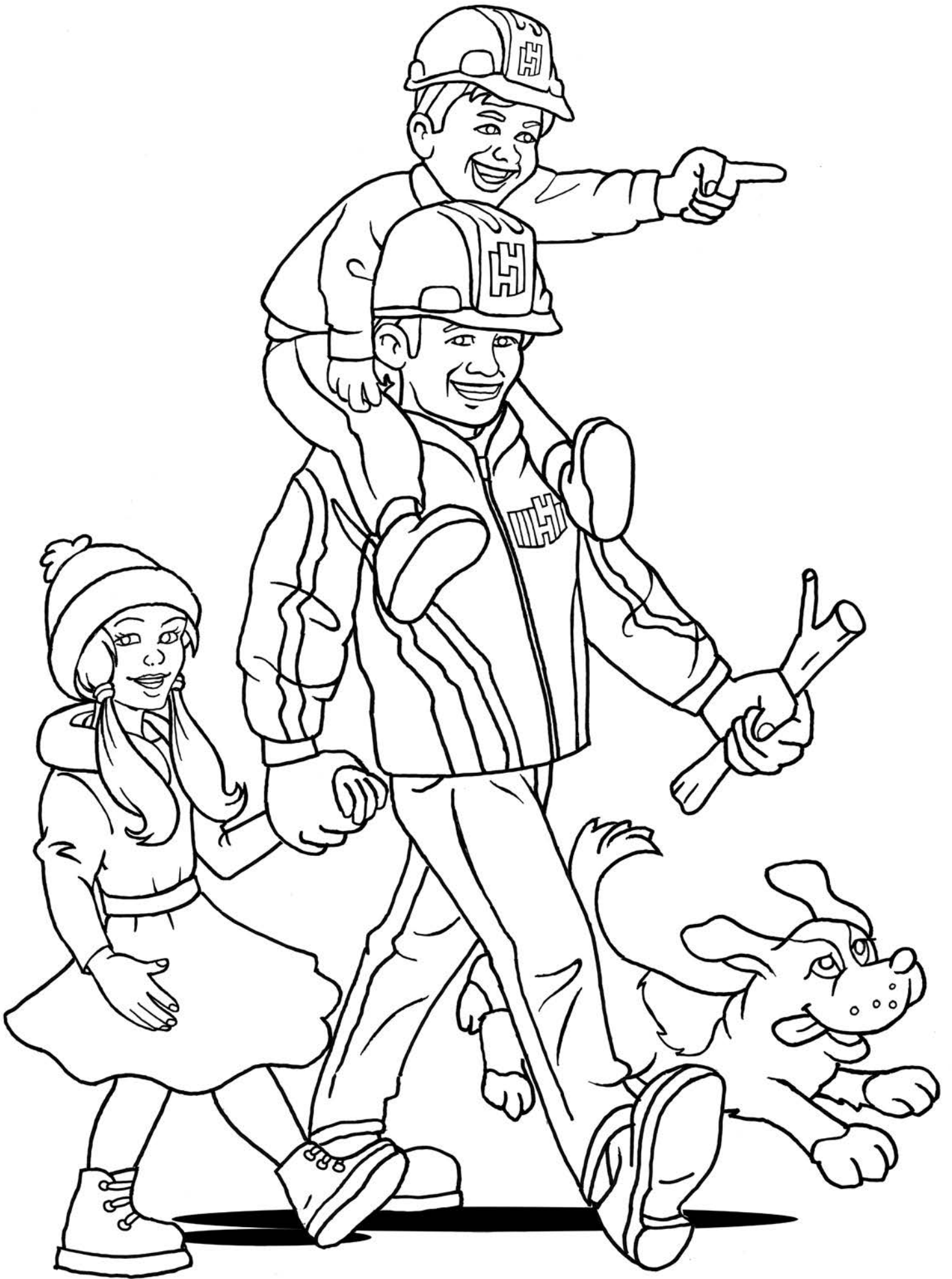

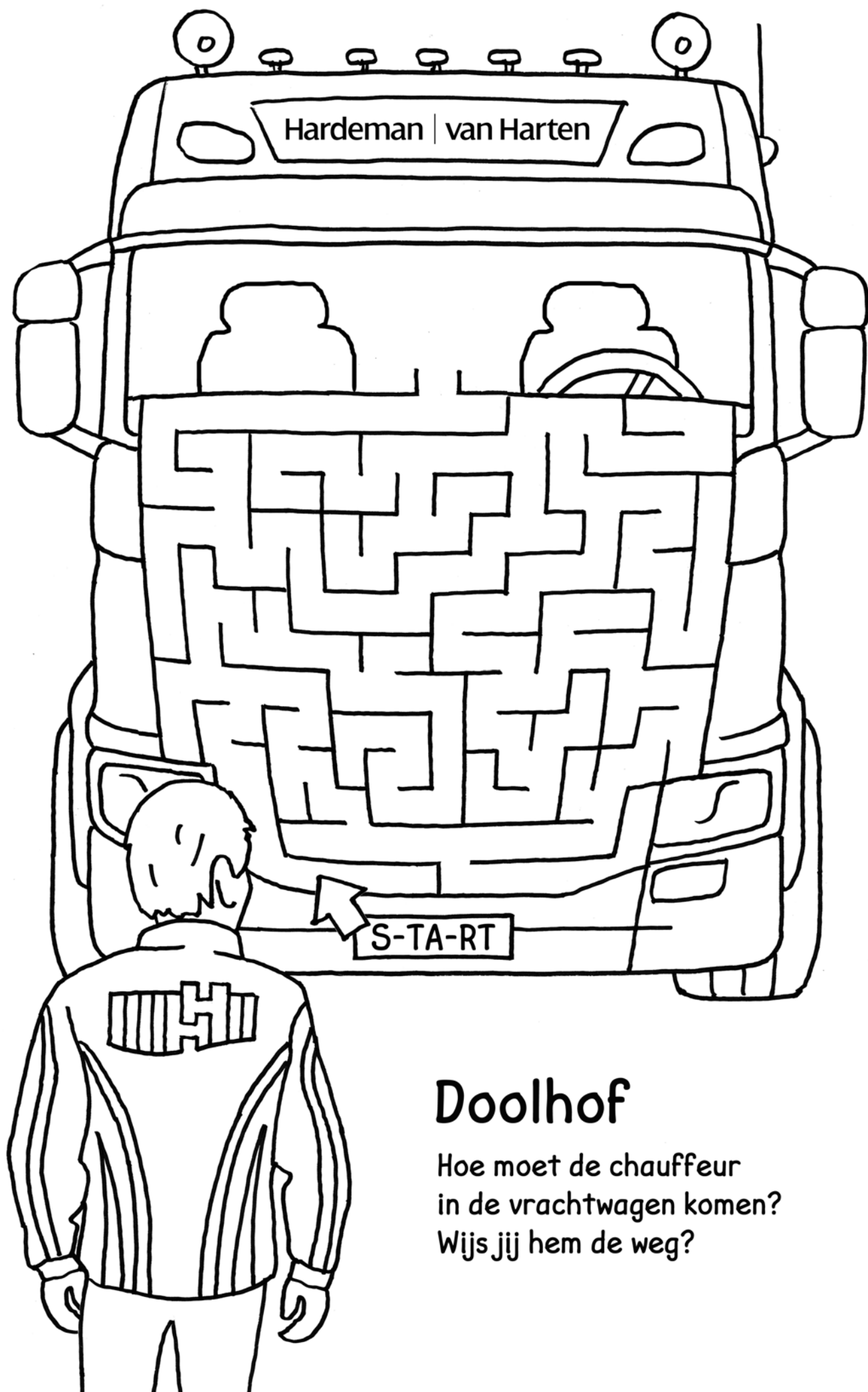

## Doolhof

Hoe moet de chauffeur  
in de vrachtwagen komen?  
Wijs jij hem de weg?



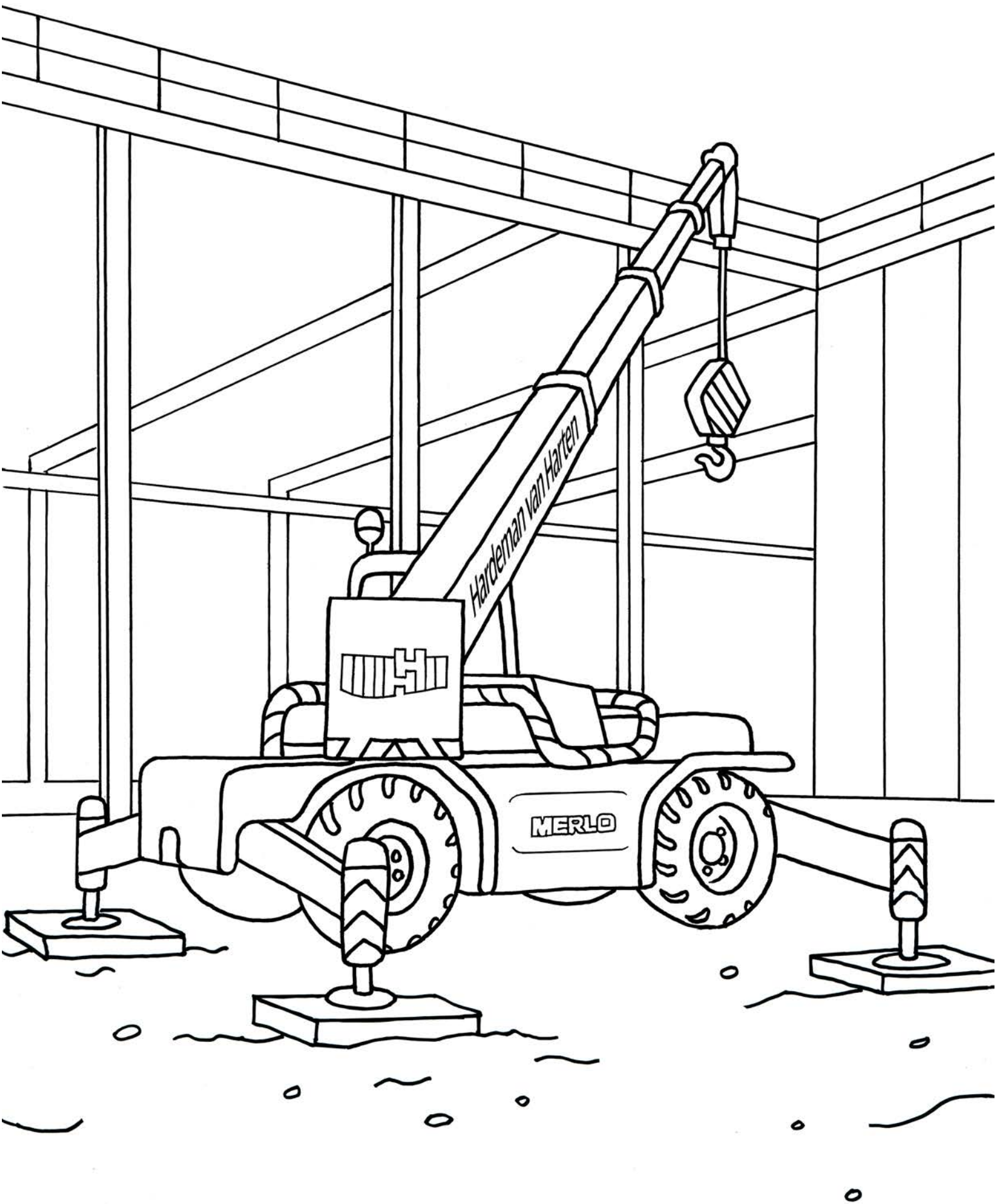



# Doolhof

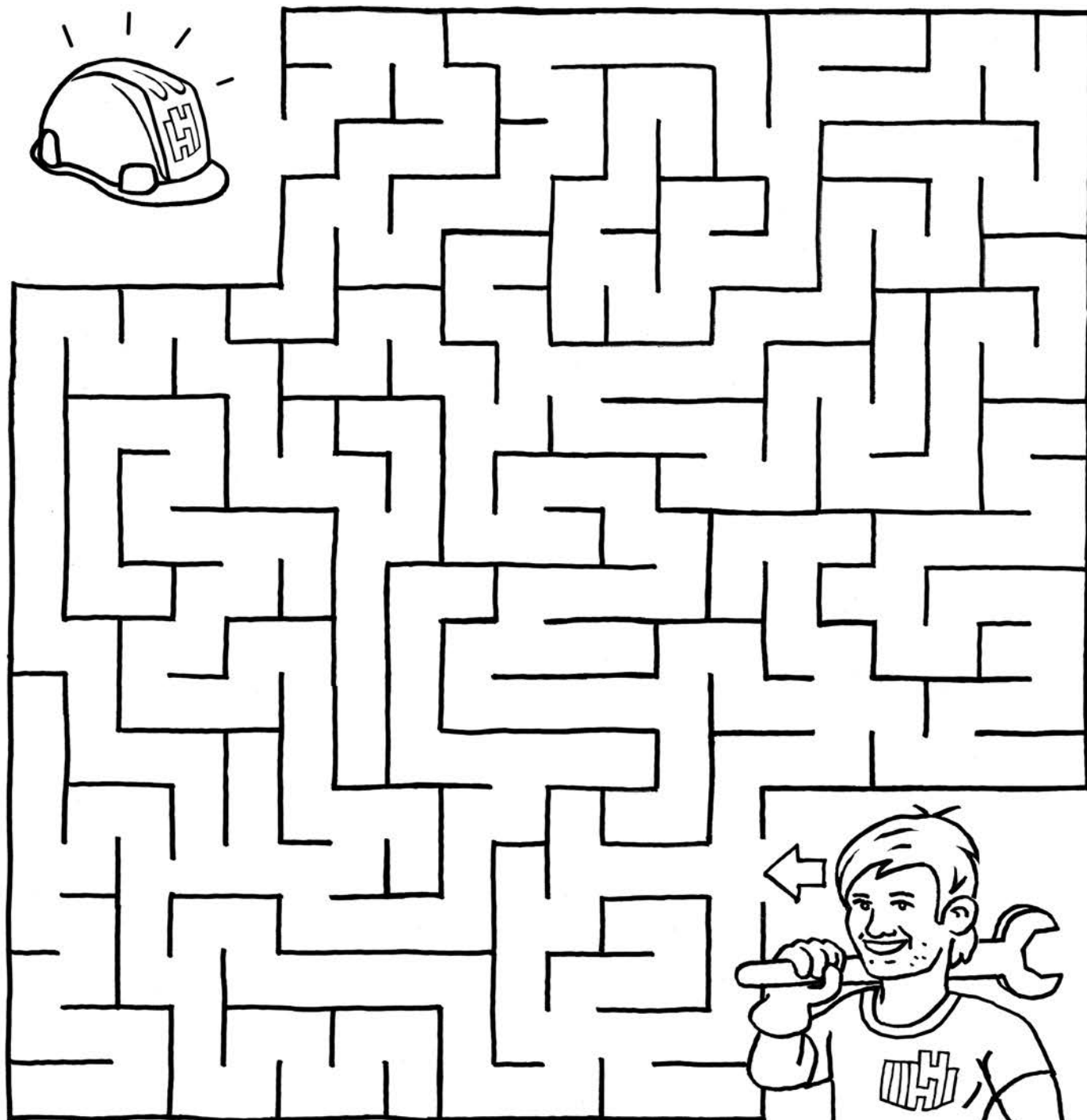

Tijdens de lunchpauze heeft iemand voor de grap Jaspers bouwhelm verstopt. Help jij hem zoeken?

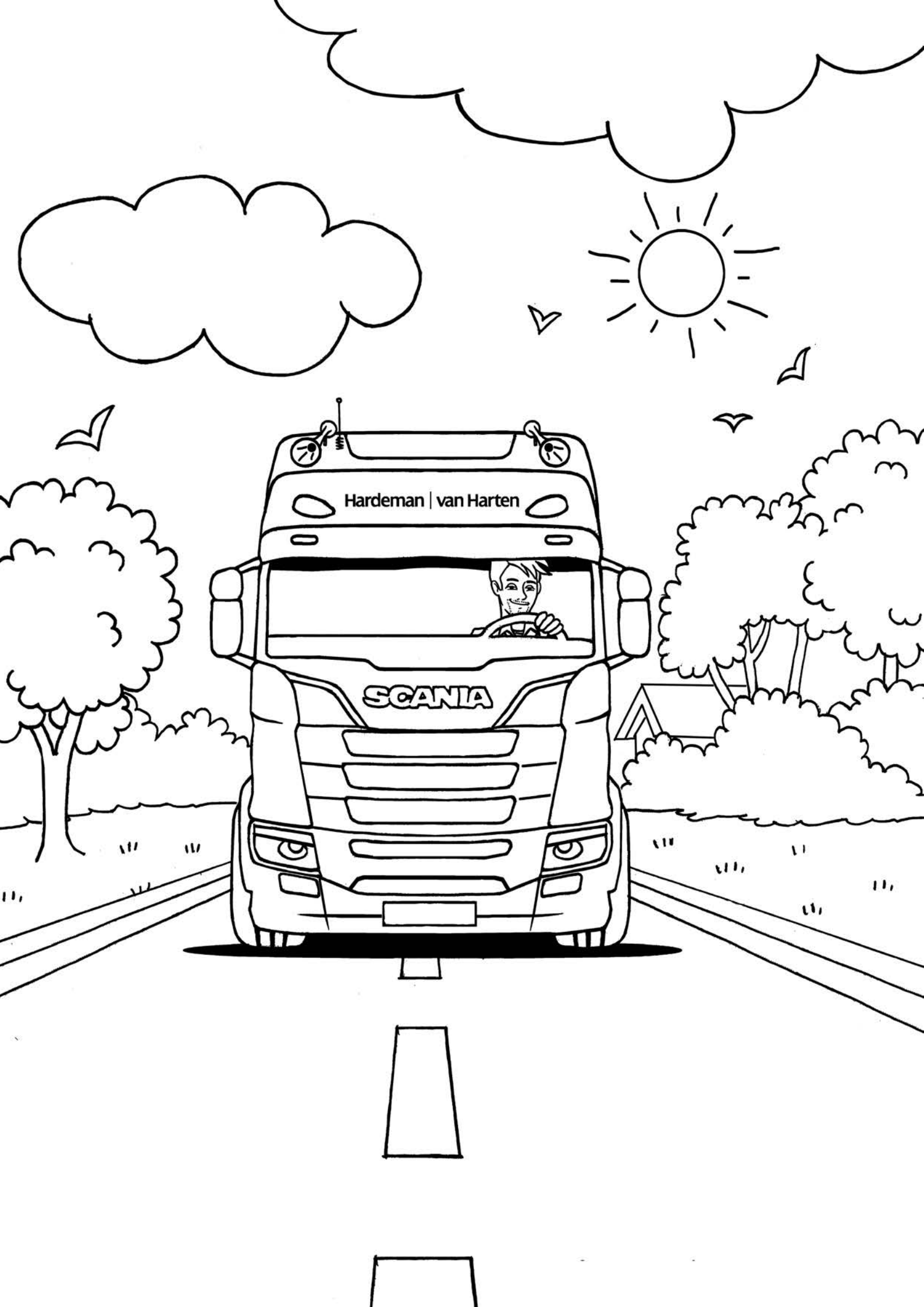

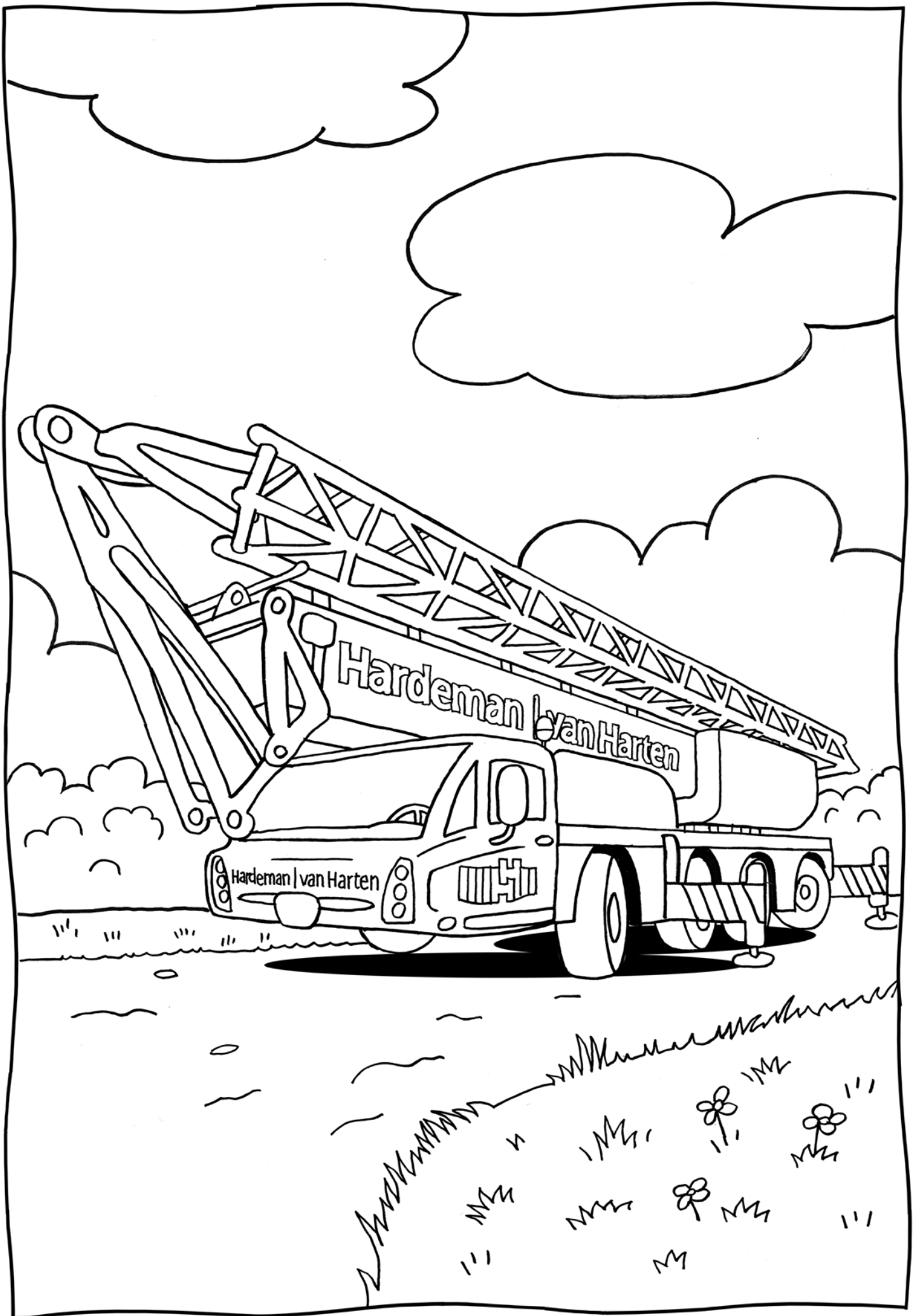

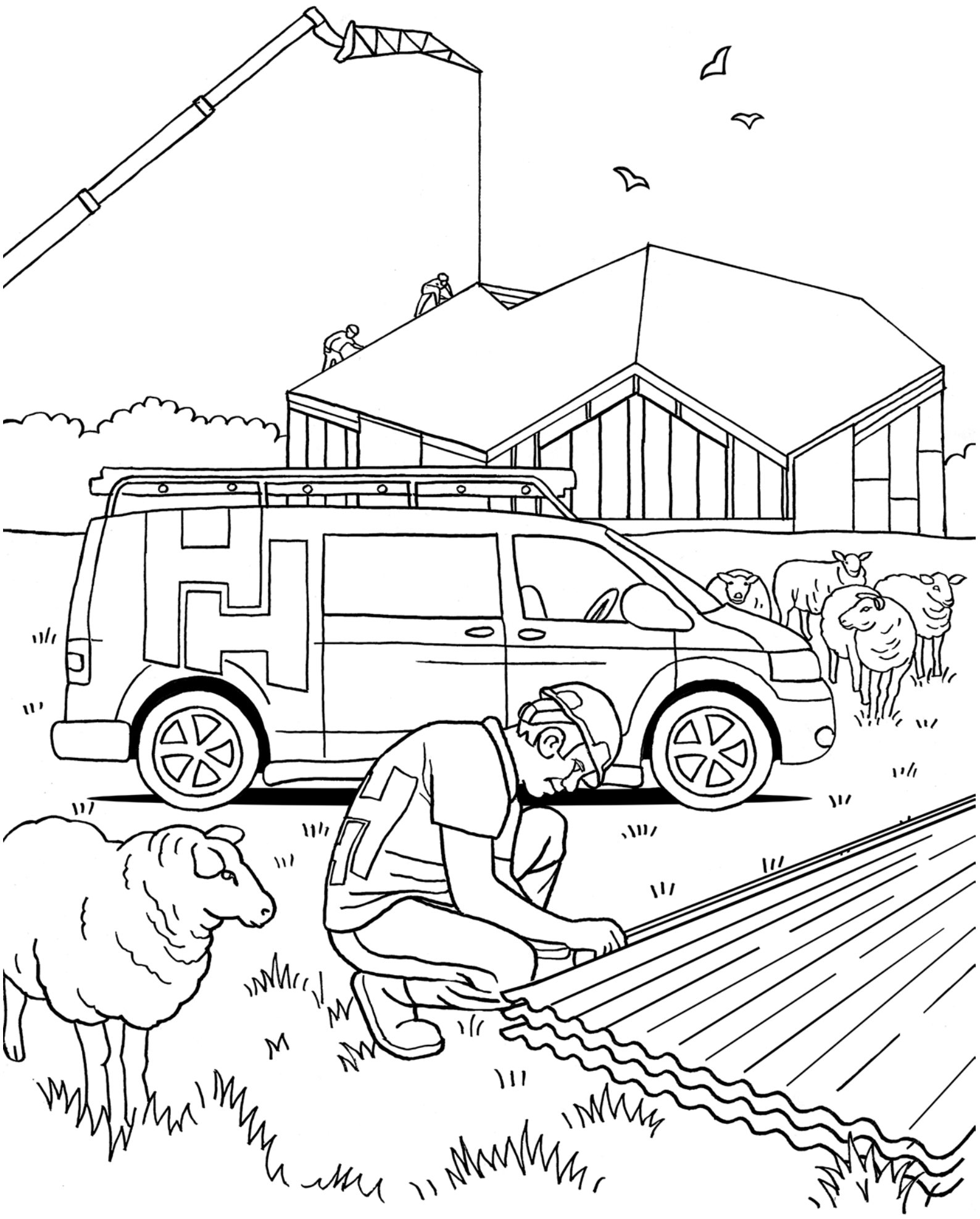

# Van stip naar stip...

Verbind de stippen die bij elkaar horen.

Begin bij stip 1 en ga door tot stip 93.

Je mag een lineaal gebruiken.

Als je klaar bent met tekenen kun je gaan inkleuren.

Succes!

Hardeman | van Harten

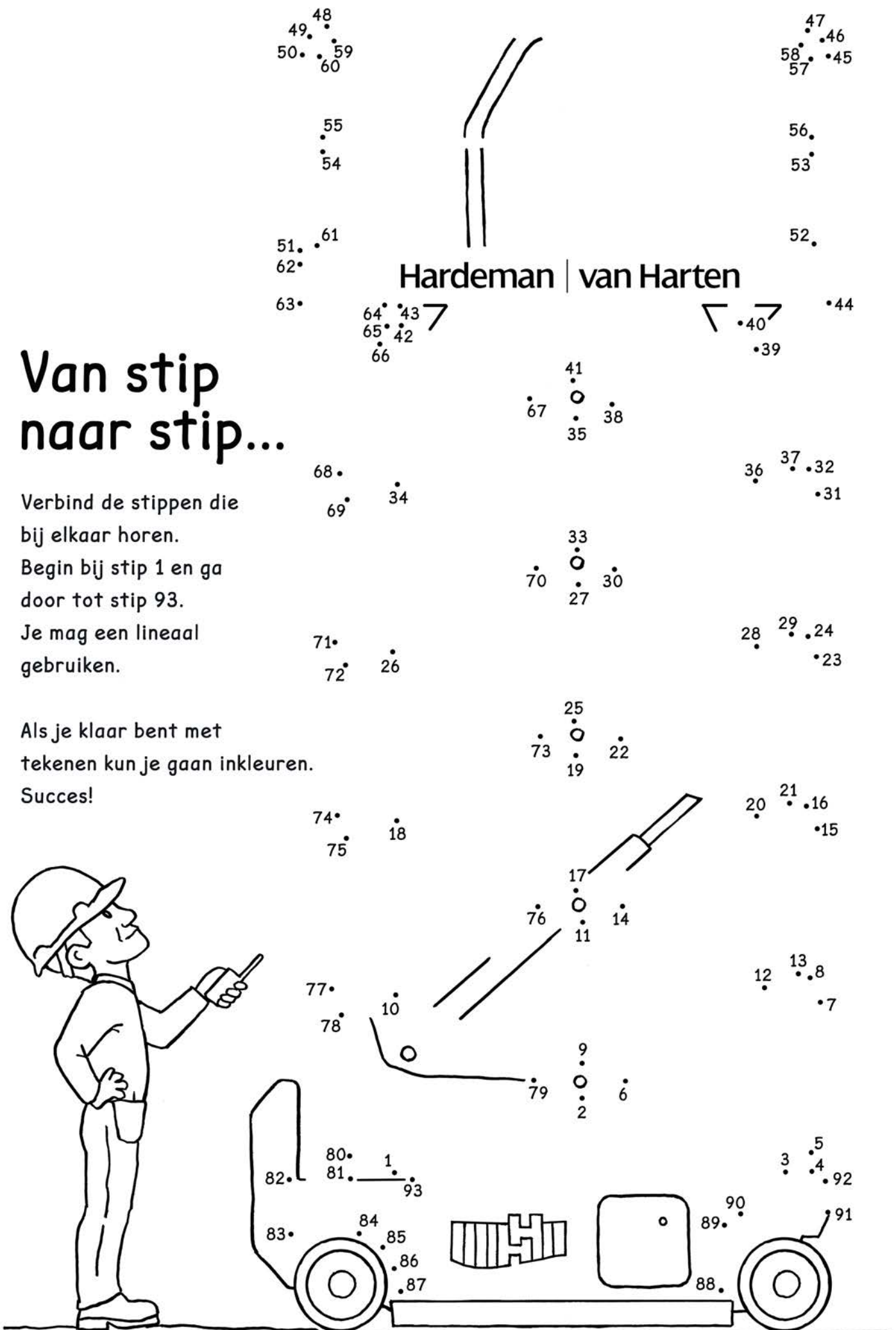

# Van stip naar stip...

Verbind de stippen die bij elkaar horen. Begin bij stip 1 en ga door tot stip 72.

Trek je ook de stippelijntjes over?

Als je klaar bent met tekenen kun je gaan inkleuren.

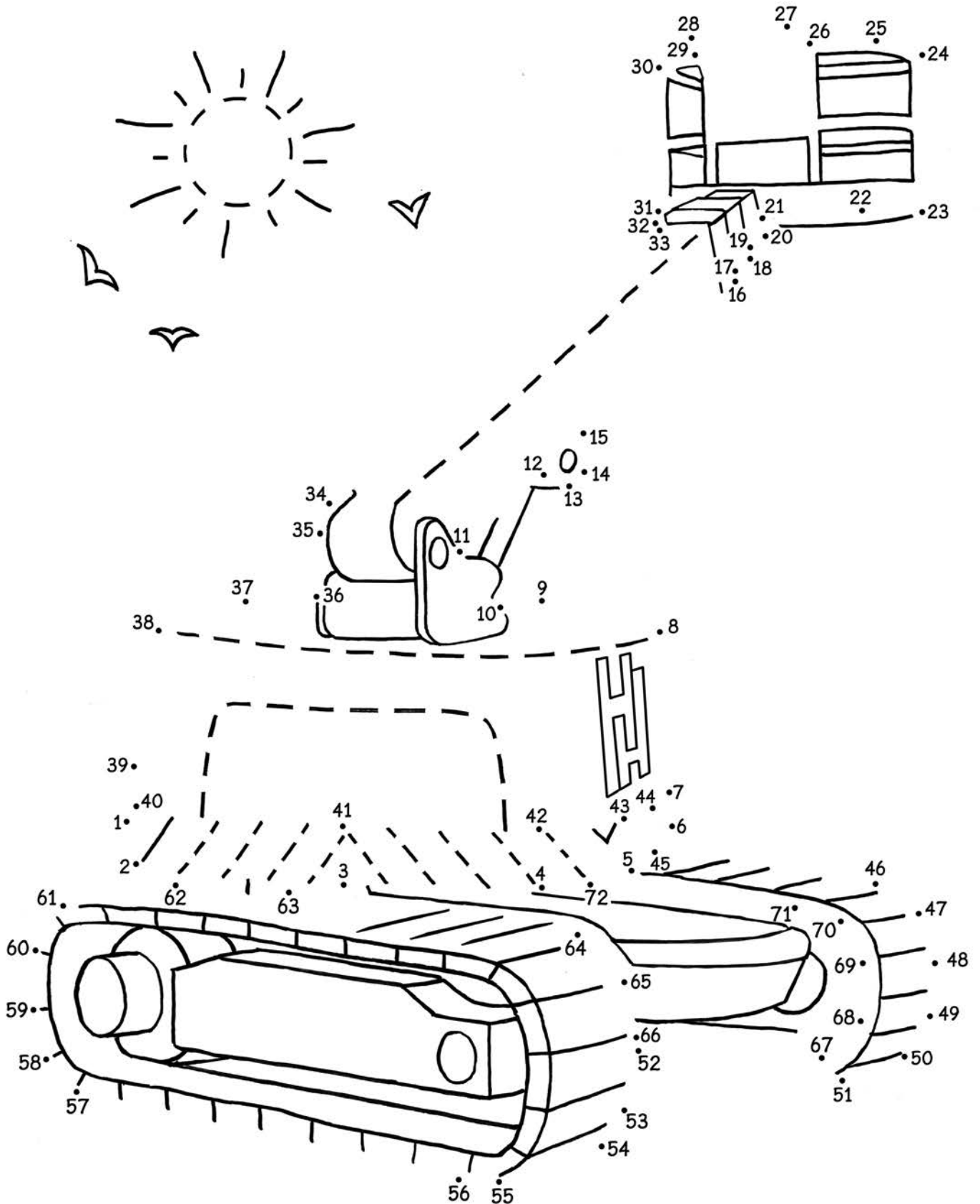

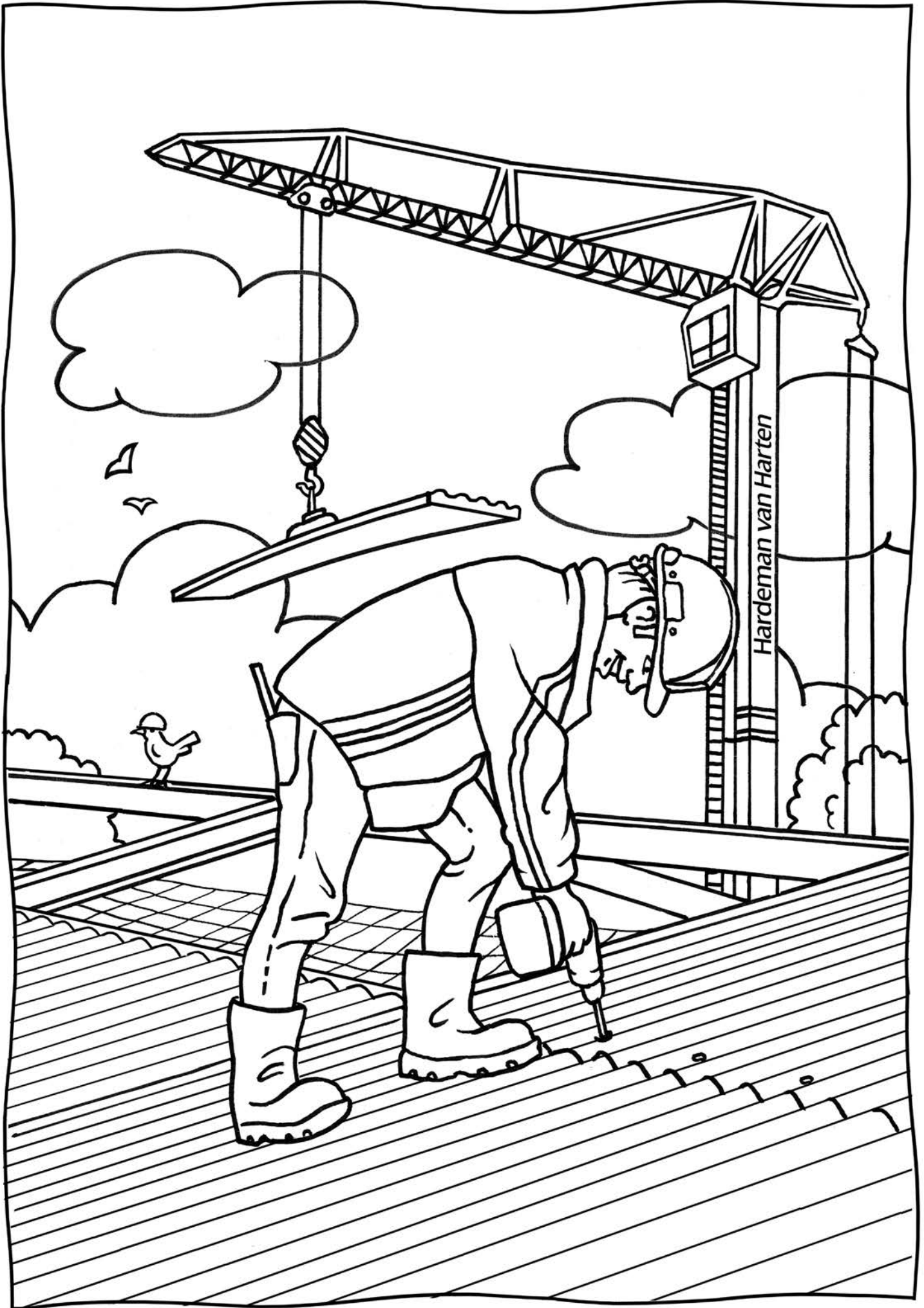





# Teamwork puzzel

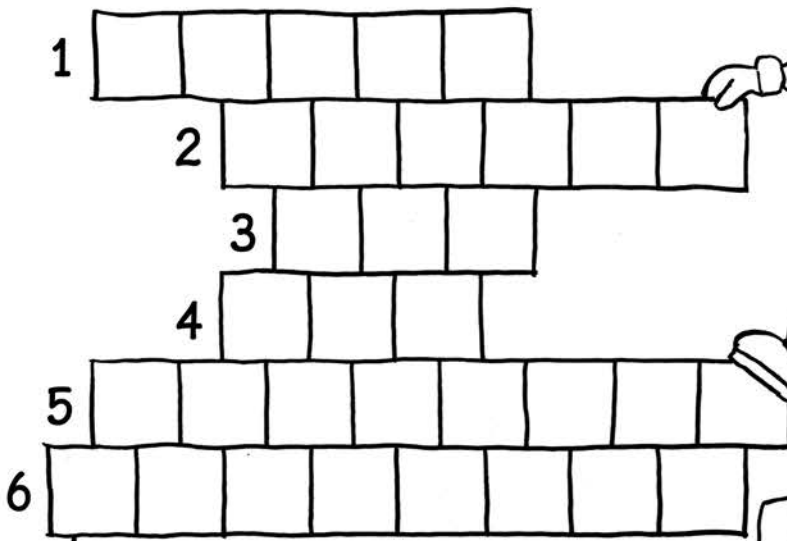

**Samuel**  
- u  
l = n



**Bo**  
+ uwen



**Daan**  
- D

Zet de uitkomst van onze namen op de juiste volgorde in de vakjes hierboven.

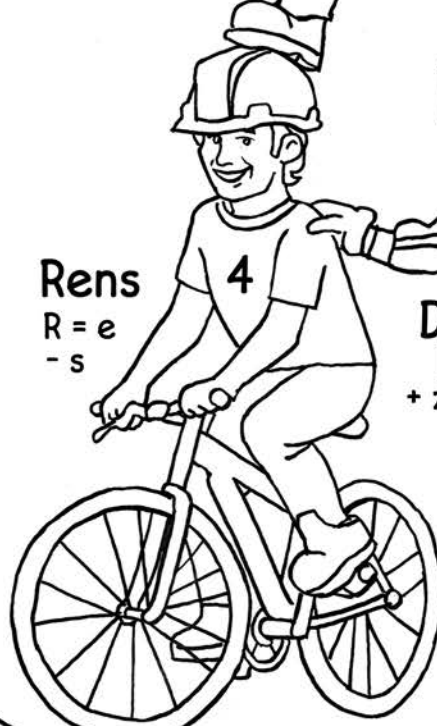

**Rens**  
R = e  
- s



**Duuk**  
k = r  
+ zame



**Ties**  
i = o  
s = k  
+ omst

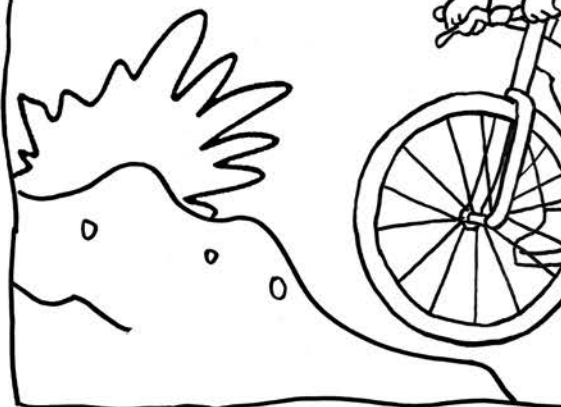





# KLEUR BOEK

**Leeftijd: 5+**

Kleurboek is een uitgave van:  
Hardeman | van Harten BV

© Hardeman | van Harten Dak & wandbeplating  
[www.hardeman-vanharten.nl](http://www.hardeman-vanharten.nl)

© Illustraties en ontwerp: Martin Soetendaal  
[www.mars3d.nl](http://www.mars3d.nl)

Alle rechten voorbehouden.



Hardeman | van Harten  
Dak & wandbeplating